

R&S® ENV432

Four-Line V-Network

User Manual



1326.6492.04 – 02

This document describes the R&S[®]ENV432 four-line V-network.

- Material number 1326.6105.02

© 2015 Rohde & Schwarz GmbH & Co. KG

Mühlendorfstr. 15, 81671 Munich, Germany

Phone: +49 89 41 29 - 0

Fax: +49 89 41 29 12 164

E-mail: info@rohde-schwarz.com

Homepage: <http://www.rohde-schwarz.com>

Printed in Germany – Subject to change – Data without tolerance limits is not binding.

R&S[®] is a trademark of Rohde & Schwarz GmbH & Co. KG.

Trade names are trademarks of the owners.

The following abbreviations are used in this manual:

R&S[®]ENV432 is abbreviated as R&S ENV432

Basic Safety Instructions

Always read through and comply with the following safety instructions!

All plants and locations of the Rohde & Schwarz group of companies make every effort to keep the safety standards of our products up to date and to offer our customers the highest possible degree of safety. Our products and the auxiliary equipment they require are designed, built and tested in accordance with the safety standards that apply in each case. Compliance with these standards is continuously monitored by our quality assurance system. The product described here has been designed, built and tested in accordance with the EC Certificate of Conformity and has left the manufacturer's plant in a condition fully complying with safety standards. To maintain this condition and to ensure safe operation, you must observe all instructions and warnings provided in this manual. If you have any questions regarding these safety instructions, the Rohde & Schwarz group of companies will be happy to answer them.



Furthermore, it is your responsibility to use the product in an appropriate manner. This product is designed for use solely in industrial and laboratory environments or, if expressly permitted, also in the field and must not be used in any way that may cause personal injury or property damage. You are responsible if the product is used for any purpose other than its designated purpose or in disregard of the manufacturer's instructions. The manufacturer shall assume no responsibility for such use of the product.

The product is used for its designated purpose if it is used in accordance with its product documentation and within its performance limits (see data sheet, documentation, the following safety instructions). Using the product requires technical skills and, in some cases, a basic knowledge of English. It is therefore essential that only skilled and specialized staff or thoroughly trained personnel with the required skills be allowed to use the product. If personal safety gear is required for using Rohde & Schwarz products, this will be indicated at the appropriate place in the product documentation. Keep the basic safety instructions and the product documentation in a safe place and pass them on to the subsequent users.

Observing the safety instructions will help prevent personal injury or damage of any kind caused by dangerous situations. Therefore, carefully read through and adhere to the following safety instructions before and when using the product. It is also absolutely essential to observe the additional safety instructions on personal safety, for example, that appear in relevant parts of the product documentation. In these safety instructions, the word "product" refers to all merchandise sold and distributed by the Rohde & Schwarz group of companies, including instruments, systems and all accessories. For product-specific information, see the data sheet and the product documentation.

Safety labels on products

The following safety labels are used on products to warn against risks and dangers.

Symbol	Meaning	Symbol	Meaning
	Notice, general danger location Observe product documentation	○	ON/OFF supply voltage
	Caution when handling heavy equipment	⏻	Standby indication
	Danger of electric shock	— — —	Direct current (DC)

Basic Safety Instructions

Symbol	Meaning	Symbol	Meaning
	Warning! Hot surface		Alternating current (AC)
	Protective conductor terminal		Direct/alternating current (DC/AC)
	Ground		Device fully protected by double (reinforced) insulation
	Ground terminal		EU labeling for batteries and accumulators For additional information, see section "Waste disposal/Environmental protection", item 1.
	Be careful when handling electrostatic sensitive devices		EU labeling for separate collection of electrical and electronic devices For additional information, see section "Waste disposal/Environmental protection", item 2.
	Warning! Laser radiation For additional information, see section "Operation", item 7.		

Signal words and their meaning

The following signal words are used in the product documentation in order to warn the reader about risks and dangers.



Indicates a hazardous situation which, if not avoided, will result in death or serious injury.



Indicates a hazardous situation which, if not avoided, could result in death or serious injury.



Indicates a hazardous situation which, if not avoided, could result in minor or moderate injury.



Indicates information considered important, but not hazard-related, e.g. messages relating to property damage.
In the product documentation, the word ATTENTION is used synonymously.

These signal words are in accordance with the standard definition for civil applications in the European Economic Area. Definitions that deviate from the standard definition may also exist in other economic areas or military applications. It is therefore essential to make sure that the signal words described here are always used only in connection with the related product documentation and the related product. The use of signal words in connection with unrelated products or documentation can result in misinterpretation and in personal injury or material damage.

Basic Safety Instructions

Operating states and operating positions

The product may be operated only under the operating conditions and in the positions specified by the manufacturer, without the product's ventilation being obstructed. If the manufacturer's specifications are not observed, this can result in electric shock, fire and/or serious personal injury or death. Applicable local or national safety regulations and rules for the prevention of accidents must be observed in all work performed.

1. Unless otherwise specified, the following requirements apply to Rohde & Schwarz products: predefined operating position is always with the housing floor facing down, IP protection 2X, use only indoors, max. operating altitude 2000 m above sea level, max. transport altitude 4500 m above sea level. A tolerance of $\pm 10\%$ shall apply to the nominal voltage and $\pm 5\%$ to the nominal frequency, overvoltage category 2, pollution severity 2.
2. Do not place the product on surfaces, vehicles, cabinets or tables that for reasons of weight or stability are unsuitable for this purpose. Always follow the manufacturer's installation instructions when installing the product and fastening it to objects or structures (e.g. walls and shelves). An installation that is not carried out as described in the product documentation could result in personal injury or even death.
3. Do not place the product on heat-generating devices such as radiators or fan heaters. The ambient temperature must not exceed the maximum temperature specified in the product documentation or in the data sheet. Product overheating can cause electric shock, fire and/or serious personal injury or even death.

Electrical safety

If the information on electrical safety is not observed either at all or to the extent necessary, electric shock, fire and/or serious personal injury or death may occur.

1. Prior to switching on the product, always ensure that the nominal voltage setting on the product matches the nominal voltage of the AC supply network. If a different voltage is to be set, the power fuse of the product may have to be changed accordingly.
2. In the case of products of safety class I with movable power cord and connector, operation is permitted only on sockets with a protective conductor contact and protective conductor.
3. Intentionally breaking the protective conductor either in the feed line or in the product itself is not permitted. Doing so can result in the danger of an electric shock from the product. If extension cords or connector strips are implemented, they must be checked on a regular basis to ensure that they are safe to use.
4. If there is no power switch for disconnecting the product from the AC supply network, or if the power switch is not suitable for this purpose, use the plug of the connecting cable to disconnect the product from the AC supply network. In such cases, always ensure that the power plug is easily reachable and accessible at all times. For example, if the power plug is the disconnecting device, the length of the connecting cable must not exceed 3 m. Functional or electronic switches are not suitable for providing disconnection from the AC supply network. If products without power switches are integrated into racks or systems, the disconnecting device must be provided at the system level.
5. Never use the product if the power cable is damaged. Check the power cables on a regular basis to ensure that they are in proper operating condition. By taking appropriate safety measures and carefully laying the power cable, ensure that the cable cannot be damaged and that no one can be hurt by, for example, tripping over the cable or suffering an electric shock.

Basic Safety Instructions

6. The product may be operated only from TN/TT supply networks fuse-protected with max. 16 A (higher fuse only after consulting with the Rohde & Schwarz group of companies).
7. Do not insert the plug into sockets that are dusty or dirty. Insert the plug firmly and all the way into the socket provided for this purpose. Otherwise, sparks that result in fire and/or injuries may occur.
8. Do not overload any sockets, extension cords or connector strips; doing so can cause fire or electric shocks.
9. For measurements in circuits with voltages $V_{rms} > 30$ V, suitable measures (e.g. appropriate measuring equipment, fuse protection, current limiting, electrical separation, insulation) should be taken to avoid any hazards.
10. Ensure that the connections with information technology equipment, e.g. PCs or other industrial computers, comply with the IEC60950-1/EN60950-1 or IEC61010-1/EN 61010-1 standards that apply in each case.
11. Unless expressly permitted, never remove the cover or any part of the housing while the product is in operation. Doing so will expose circuits and components and can lead to injuries, fire or damage to the product.
12. If a product is to be permanently installed, the connection between the protective conductor terminal on site and the product's protective conductor must be made first before any other connection is made. The product may be installed and connected only by a licensed electrician.
13. For permanently installed equipment without built-in fuses, circuit breakers or similar protective devices, the supply circuit must be fuse-protected in such a way that anyone who has access to the product, as well as the product itself, is adequately protected from injury or damage.
14. Use suitable overvoltage protection to ensure that no overvoltage (such as that caused by a bolt of lightning) can reach the product. Otherwise, the person operating the product will be exposed to the danger of an electric shock.
15. Any object that is not designed to be placed in the openings of the housing must not be used for this purpose. Doing so can cause short circuits inside the product and/or electric shocks, fire or injuries.
16. Unless specified otherwise, products are not liquid-proof (see also section "Operating states and operating positions", item 1). Therefore, the equipment must be protected against penetration by liquids. If the necessary precautions are not taken, the user may suffer electric shock or the product itself may be damaged, which can also lead to personal injury.
17. Never use the product under conditions in which condensation has formed or can form in or on the product, e.g. if the product has been moved from a cold to a warm environment. Penetration by water increases the risk of electric shock.
18. Prior to cleaning the product, disconnect it completely from the power supply (e.g. AC supply network or battery). Use a soft, non-linting cloth to clean the product. Never use chemical cleaning agents such as alcohol, acetone or diluents for cellulose lacquers.

Operation

1. Operating the products requires special training and intense concentration. Make sure that persons who use the products are physically, mentally and emotionally fit enough to do so; otherwise, injuries or material damage may occur. It is the responsibility of the employer/operator to select suitable personnel for operating the products.

Basic Safety Instructions

2. Before you move or transport the product, read and observe the section titled "Transport".
3. As with all industrially manufactured goods, the use of substances that induce an allergic reaction (allergens) such as nickel cannot be generally excluded. If you develop an allergic reaction (such as a skin rash, frequent sneezing, red eyes or respiratory difficulties) when using a Rohde & Schwarz product, consult a physician immediately to determine the cause and to prevent health problems or stress.
4. Before you start processing the product mechanically and/or thermally, or before you take it apart, be sure to read and pay special attention to the section titled "Waste disposal/Environmental protection", item 1.
5. Depending on the function, certain products such as RF radio equipment can produce an elevated level of electromagnetic radiation. Considering that unborn babies require increased protection, pregnant women must be protected by appropriate measures. Persons with pacemakers may also be exposed to risks from electromagnetic radiation. The employer/operator must evaluate workplaces where there is a special risk of exposure to radiation and, if necessary, take measures to avert the potential danger.
6. Should a fire occur, the product may release hazardous substances (gases, fluids, etc.) that can cause health problems. Therefore, suitable measures must be taken, e.g. protective masks and protective clothing must be worn.
7. Laser products are given warning labels that are standardized according to their laser class. Lasers can cause biological harm due to the properties of their radiation and due to their extremely concentrated electromagnetic power. If a laser product (e.g. a CD/DVD drive) is integrated into a Rohde & Schwarz product, absolutely no other settings or functions may be used as described in the product documentation. The objective is to prevent personal injury (e.g. due to laser beams).
8. EMC classes (in line with EN 55011/CISPR 11, and analogously with EN 55022/CISPR 22, EN 55032/CISPR 32)
 - Class A equipment:
Equipment suitable for use in all environments except residential environments and environments that are directly connected to a low-voltage supply network that supplies residential buildings
Note: Class A equipment is intended for use in an industrial environment. This equipment may cause radio disturbances in residential environments, due to possible conducted as well as radiated disturbances. In this case, the operator may be required to take appropriate measures to eliminate these disturbances.
 - Class B equipment:
Equipment suitable for use in residential environments and environments that are directly connected to a low-voltage supply network that supplies residential buildings

Repair and service

1. The product may be opened only by authorized, specially trained personnel. Before any work is performed on the product or before the product is opened, it must be disconnected from the AC supply network. Otherwise, personnel will be exposed to the risk of an electric shock.

Basic Safety Instructions

- Adjustments, replacement of parts, maintenance and repair may be performed only by electrical experts authorized by Rohde & Schwarz. Only original parts may be used for replacing parts relevant to safety (e.g. power switches, power transformers, fuses). A safety test must always be performed after parts relevant to safety have been replaced (visual inspection, protective conductor test, insulation resistance measurement, leakage current measurement, functional test). This helps ensure the continued safety of the product.

Batteries and rechargeable batteries/cells

If the information regarding batteries and rechargeable batteries/cells is not observed either at all or to the extent necessary, product users may be exposed to the risk of explosions, fire and/or serious personal injury, and, in some cases, death. Batteries and rechargeable batteries with alkaline electrolytes (e.g. lithium cells) must be handled in accordance with the EN 62133 standard.

- Cells must not be taken apart or crushed.
- Cells or batteries must not be exposed to heat or fire. Storage in direct sunlight must be avoided. Keep cells and batteries clean and dry. Clean soiled connectors using a dry, clean cloth.
- Cells or batteries must not be short-circuited. Cells or batteries must not be stored in a box or in a drawer where they can short-circuit each other, or where they can be short-circuited by other conductive materials. Cells and batteries must not be removed from their original packaging until they are ready to be used.
- Cells and batteries must not be exposed to any mechanical shocks that are stronger than permitted.
- If a cell develops a leak, the fluid must not be allowed to come into contact with the skin or eyes. If contact occurs, wash the affected area with plenty of water and seek medical aid.
- Improperly replacing or charging cells or batteries that contain alkaline electrolytes (e.g. lithium cells) can cause explosions. Replace cells or batteries only with the matching Rohde & Schwarz type (see parts list) in order to ensure the safety of the product.
- Cells and batteries must be recycled and kept separate from residual waste. Rechargeable batteries and normal batteries that contain lead, mercury or cadmium are hazardous waste. Observe the national regulations regarding waste disposal and recycling.

Transport

- The product may be very heavy. Therefore, the product must be handled with care. In some cases, the user may require a suitable means of lifting or moving the product (e.g. with a lift-truck) to avoid back or other physical injuries.
- Handles on the products are designed exclusively to enable personnel to transport the product. It is therefore not permissible to use handles to fasten the product to or on transport equipment such as cranes, fork lifts, wagons, etc. The user is responsible for securely fastening the products to or on the means of transport or lifting. Observe the safety regulations of the manufacturer of the means of transport or lifting. Noncompliance can result in personal injury or material damage.
- If you use the product in a vehicle, it is the sole responsibility of the driver to drive the vehicle safely and properly. The manufacturer assumes no responsibility for accidents or collisions. Never use the product in a moving vehicle if doing so could distract the driver of the vehicle. Adequately secure the product in the vehicle to prevent injuries or other damage in the event of an accident.

Instrucciones de seguridad elementales

Waste disposal/Environmental protection

1. Specially marked equipment has a battery or accumulator that must not be disposed of with unsorted municipal waste, but must be collected separately. It may only be disposed of at a suitable collection point or via a Rohde & Schwarz customer service center.
2. Waste electrical and electronic equipment must not be disposed of with unsorted municipal waste, but must be collected separately.
Rohde & Schwarz GmbH & Co. KG has developed a disposal concept and takes full responsibility for take-back obligations and disposal obligations for manufacturers within the EU. Contact your Rohde & Schwarz customer service center for environmentally responsible disposal of the product.
3. If products or their components are mechanically and/or thermally processed in a manner that goes beyond their intended use, hazardous substances (heavy-metal dust such as lead, beryllium, nickel) may be released. For this reason, the product may only be disassembled by specially trained personnel. Improper disassembly may be hazardous to your health. National waste disposal regulations must be observed.
4. If handling the product releases hazardous substances or fuels that must be disposed of in a special way, e.g. coolants or engine oils that must be replenished regularly, the safety instructions of the manufacturer of the hazardous substances or fuels and the applicable regional waste disposal regulations must be observed. Also observe the relevant safety instructions in the product documentation. The improper disposal of hazardous substances or fuels can cause health problems and lead to environmental damage.

For additional information about environmental protection, visit the Rohde & Schwarz website.

Instrucciones de seguridad elementales

¡Es imprescindible leer y cumplir las siguientes instrucciones e informaciones de seguridad!

El principio del grupo de empresas Rohde & Schwarz consiste en tener nuestros productos siempre al día con los estándares de seguridad y de ofrecer a nuestros clientes el máximo grado de seguridad. Nuestros productos y todos los equipos adicionales son siempre fabricados y examinados según las normas de seguridad vigentes. Nuestro sistema de garantía de calidad controla constantemente que sean cumplidas estas normas. El presente producto ha sido fabricado y examinado según el certificado de conformidad de la UE y ha salido de nuestra planta en estado impecable según los estándares técnicos de seguridad. Para poder preservar este estado y garantizar un funcionamiento libre de peligros, el usuario deberá atenerse a todas las indicaciones, informaciones de seguridad y notas de alerta. El grupo de empresas Rohde & Schwarz está siempre a su disposición en caso de que tengan preguntas referentes a estas informaciones de seguridad.

Además queda en la responsabilidad del usuario utilizar el producto en la forma debida. Este producto está destinado exclusivamente al uso en la industria y el laboratorio o, si ha sido expresamente autorizado, para aplicaciones de campo y de ninguna manera deberá ser utilizado de modo que alguna persona/cosa pueda sufrir daño. El uso del producto fuera de sus fines definidos o sin tener en cuenta las instrucciones del fabricante queda en la responsabilidad del usuario. El fabricante no se hace en ninguna forma responsable de consecuencias a causa del mal uso del producto.















Instrucciones de seguridad elementales

Se parte del uso correcto del producto para los fines definidos si el producto es utilizado conforme a las indicaciones de la correspondiente documentación del producto y dentro del margen de rendimiento definido (ver hoja de datos, documentación, informaciones de seguridad que siguen). El uso del producto hace necesarios conocimientos técnicos y ciertos conocimientos del idioma inglés. Por eso se debe tener en cuenta que el producto solo pueda ser operado por personal especializado o personas instruidas en profundidad con las capacidades correspondientes. Si fuera necesaria indumentaria de seguridad para el uso de productos de Rohde & Schwarz, encontraría la información debida en la documentación del producto en el capítulo correspondiente. Guarde bien las informaciones de seguridad elementales, así como la documentación del producto, y entréguelas a usuarios posteriores.



Tener en cuenta las informaciones de seguridad sirve para evitar en lo posible lesiones o daños por peligros de toda clase. Por eso es imprescindible leer detalladamente y comprender por completo las siguientes informaciones de seguridad antes de usar el producto, y respetarlas durante el uso del producto. Deberán tenerse en cuenta todas las demás informaciones de seguridad, como p. ej. las referentes a la protección de personas, que encontrarán en el capítulo correspondiente de la documentación del producto y que también son de obligado cumplimiento. En las presentes informaciones de seguridad se recogen todos los objetos que distribuye el grupo de empresas Rohde & Schwarz bajo la denominación de "producto", entre ellos también aparatos, instalaciones así como toda clase de accesorios. Los datos específicos del producto figuran en la hoja de datos y en la documentación del producto.

Señalización de seguridad de los productos

Las siguientes señales de seguridad se utilizan en los productos para advertir sobre riesgos y peligros.

Símbolo	Significado	Símbolo	Significado
	Aviso: punto de peligro general Observar la documentación del producto		Tensión de alimentación de PUESTA EN MARCHA / PARADA
	Atención en el manejo de dispositivos de peso elevado		Indicación de estado de espera (standby)
	Peligro de choque eléctrico		Corriente continua (DC)
	Advertencia: superficie caliente		Corriente alterna (AC)
	Conexión a conductor de protección		Corriente continua / Corriente alterna (DC/AC)
	Conexión a tierra		El aparato está protegido en su totalidad por un aislamiento doble (reforzado)
	Conexión a masa		Distintivo de la UE para baterías y acumuladores Más información en la sección "Eliminación/protección del medio ambiente", punto 1.

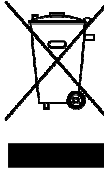
Instrucciones de seguridad elementales

Símbolo	Significado	Símbolo	Significado
	Aviso: Cuidado en el manejo de dispositivos sensibles a la electrostática (ESD)		Distintivo de la UE para la eliminación por separado de dispositivos eléctricos y electrónicos Más información en la sección "Eliminación/protección del medio ambiente", punto 2.
	Advertencia: rayo láser Más información en la sección "Funcionamiento", punto 7.		

Palabras de señal y su significado

En la documentación del producto se utilizan las siguientes palabras de señal con el fin de advertir contra riesgos y peligros.



Indica una situación de peligro que, si no se evita, causa lesiones graves o incluso la muerte.



Indica una situación de peligro que, si no se evita, puede causar lesiones graves o incluso la muerte.



Indica una situación de peligro que, si no se evita, puede causar lesiones leves o moderadas.



Indica información que se considera importante, pero no en relación con situaciones de peligro; p. ej., avisos sobre posibles daños materiales.

En la documentación del producto se emplea de forma sinónima el término CUIDADO.

Las palabras de señal corresponden a la definición habitual para aplicaciones civiles en el área económica europea. Pueden existir definiciones diferentes a esta definición en otras áreas económicas o en aplicaciones militares. Por eso se deberá tener en cuenta que las palabras de señal aquí descritas sean utilizadas siempre solamente en combinación con la correspondiente documentación del producto y solamente en combinación con el producto correspondiente. La utilización de las palabras de señal en combinación con productos o documentaciones que no les correspondan puede llevar a interpretaciones equivocadas y tener por consecuencia daños en personas u objetos.

Estados operativos y posiciones de funcionamiento

El producto solamente debe ser utilizado según lo indicado por el fabricante respecto a los estados operativos y posiciones de funcionamiento sin que se obstruya la ventilación. Si no se siguen las indicaciones del fabricante, pueden producirse choques eléctricos, incendios y/o lesiones graves con posible consecuencia de muerte. En todos los trabajos deberán ser tenidas en cuenta las normas nacionales y locales de seguridad del trabajo y de prevención de accidentes.

Instrucciones de seguridad elementales

1. Si no se convino de otra manera, es para los productos Rohde & Schwarz válido lo que sigue: como posición de funcionamiento se define por principio la posición con el suelo de la caja para abajo, modo de protección IP 2X, uso solamente en estancias interiores, utilización hasta 2000 m sobre el nivel del mar, transporte hasta 4500 m sobre el nivel del mar. Se aplicará una tolerancia de ± 10 % sobre el voltaje nominal y de ± 5 % sobre la frecuencia nominal. Categoría de sobrecarga eléctrica 2, índice de suciedad 2.
2. No sitúe el producto encima de superficies, vehículos, estantes o mesas, que por sus características de peso o de estabilidad no sean aptos para él. Siga siempre las instrucciones de instalación del fabricante cuando instale y asegure el producto en objetos o estructuras (p. ej. paredes y estantes). Si se realiza la instalación de modo distinto al indicado en la documentación del producto, se pueden causar lesiones o, en determinadas circunstancias, incluso la muerte.
3. No ponga el producto sobre aparatos que generen calor (p. ej. radiadores o calefactores). La temperatura ambiente no debe superar la temperatura máxima especificada en la documentación del producto o en la hoja de datos. En caso de sobrecalentamiento del producto, pueden producirse choques eléctricos, incendios y/o lesiones graves con posible consecuencia de muerte.

Seguridad eléctrica

Si no se siguen (o se siguen de modo insuficiente) las indicaciones del fabricante en cuanto a seguridad eléctrica, pueden producirse choques eléctricos, incendios y/o lesiones graves con posible consecuencia de muerte.

1. Antes de la puesta en marcha del producto se deberá comprobar siempre que la tensión preseleccionada en el producto coincida con la de la red de alimentación eléctrica. Si es necesario modificar el ajuste de tensión, también se deberán cambiar en caso dado los fusibles correspondientes del producto.
2. Los productos de la clase de protección I con alimentación móvil y enchufe individual solamente podrán enchufarse a tomas de corriente con contacto de seguridad y con conductor de protección conectado.
3. Queda prohibida la interrupción intencionada del conductor de protección, tanto en la toma de corriente como en el mismo producto. La interrupción puede tener como consecuencia el riesgo de que el producto sea fuente de choques eléctricos. Si se utilizan cables alargadores o regletas de enchufe, deberá garantizarse la realización de un examen regular de los mismos en cuanto a su estado técnico de seguridad.
4. Si el producto no está equipado con un interruptor para desconectarlo de la red, o bien si el interruptor existente no resulta apropiado para la desconexión de la red, el enchufe del cable de conexión se deberá considerar como un dispositivo de desconexión. El dispositivo de desconexión se debe poder alcanzar fácilmente y debe estar siempre bien accesible. Si, p. ej., el enchufe de conexión a la red es el dispositivo de desconexión, la longitud del cable de conexión no debe superar 3 m). Los interruptores selectores o electrónicos no son aptos para el corte de la red eléctrica. Si se integran productos sin interruptor en bastidores o instalaciones, se deberá colocar el interruptor en el nivel de la instalación.
5. No utilice nunca el producto si está dañado el cable de conexión a red. Compruebe regularmente el correcto estado de los cables de conexión a red. Asegúrese, mediante las medidas de protección y de instalación adecuadas, de que el cable de conexión a red no pueda ser dañado o de que nadie pueda ser dañado por él, p. ej. al tropezar o por un choque eléctrico.

Instrucciones de seguridad elementales

6. Solamente está permitido el funcionamiento en redes de alimentación TN/TT aseguradas con fusibles de 16 A como máximo (utilización de fusibles de mayor amperaje solo previa consulta con el grupo de empresas Rohde & Schwarz).
7. Nunca conecte el enchufe en tomas de corriente sucias o llenas de polvo. Introduzca el enchufe por completo y fuertemente en la toma de corriente. La no observación de estas medidas puede provocar chispas, fuego y/o lesiones.
8. No sobrecargue las tomas de corriente, los cables alargadores o las regletas de enchufe ya que esto podría causar fuego o choques eléctricos.
9. En las mediciones en circuitos de corriente con una tensión $U_{\text{eff}} > 30 \text{ V}$ se deberán tomar las medidas apropiadas para impedir cualquier peligro (p. ej. medios de medición adecuados, seguros, limitación de tensión, corte protector, aislamiento etc.).
10. Para la conexión con dispositivos informáticos como un PC o un ordenador industrial, debe comprobarse que éstos cumplan los estándares IEC60950-1/EN60950-1 o IEC61010-1/EN 61010-1 válidos en cada caso.
11. A menos que esté permitido expresamente, no retire nunca la tapa ni componentes de la carcasa mientras el producto esté en servicio. Esto pone a descubierto los cables y componentes eléctricos y puede causar lesiones, fuego o daños en el producto.
12. Si un producto se instala en un lugar fijo, se deberá primero conectar el conductor de protección fijo con el conductor de protección del producto antes de hacer cualquier otra conexión. La instalación y la conexión deberán ser efectuadas por un electricista especializado.
13. En el caso de dispositivos fijos que no estén provistos de fusibles, interruptor automático ni otros mecanismos de seguridad similares, el circuito de alimentación debe estar protegido de modo que todas las personas que puedan acceder al producto, así como el producto mismo, estén a salvo de posibles daños.
14. Todo producto debe estar protegido contra sobretensión (debida p. ej. a una caída del rayo) mediante los correspondientes sistemas de protección. Si no, el personal que lo utilice quedará expuesto al peligro de choque eléctrico.
15. No debe introducirse en los orificios de la caja del aparato ningún objeto que no esté destinado a ello. Esto puede producir cortocircuitos en el producto y/o puede causar choques eléctricos, fuego o lesiones.
16. Salvo indicación contraria, los productos no están impermeabilizados (ver también el capítulo "Estados operativos y posiciones de funcionamiento", punto 1). Por eso es necesario tomar las medidas necesarias para evitar la entrada de líquidos. En caso contrario, existe peligro de choque eléctrico para el usuario o de daños en el producto, que también pueden redundar en peligro para las personas.
17. No utilice el producto en condiciones en las que pueda producirse o ya se hayan producido condensaciones sobre el producto o en el interior de éste, como p. ej. al desplazarlo de un lugar frío a otro caliente. La entrada de agua aumenta el riesgo de choque eléctrico.
18. Antes de la limpieza, desconecte por completo el producto de la alimentación de tensión (p. ej. red de alimentación o batería). Realice la limpieza de los aparatos con un paño suave, que no se deshilache. No utilice bajo ningún concepto productos de limpieza químicos como alcohol, acetona o diluyentes para lacas nitrocelulósicas.

Instrucciones de seguridad elementales

Funcionamiento

1. El uso del producto requiere instrucciones especiales y una alta concentración durante el manejo. Debe asegurarse que las personas que manejen el producto estén a la altura de los requerimientos necesarios en cuanto a aptitudes físicas, psíquicas y emocionales, ya que de otra manera no se pueden excluir lesiones o daños de objetos. El empresario u operador es responsable de seleccionar el personal usuario apto para el manejo del producto.
2. Antes de desplazar o transportar el producto, lea y tenga en cuenta el capítulo "Transporte".
3. Como con todo producto de fabricación industrial no puede quedar excluida en general la posibilidad de que se produzcan alergias provocadas por algunos materiales empleados —los llamados alérgenos (p. ej. el níquel)—. Si durante el manejo de productos Rohde & Schwarz se producen reacciones alérgicas, como p. ej. irritaciones cutáneas, estornudos continuos, enrojecimiento de la conjuntiva o dificultades respiratorias, debe avisarse inmediatamente a un médico para investigar las causas y evitar cualquier molestia o daño a la salud.
4. Antes de la manipulación mecánica y/o térmica o el desmontaje del producto, debe tenerse en cuenta imprescindiblemente el capítulo "Eliminación/protección del medio ambiente", punto 1.
5. Ciertos productos, como p. ej. las instalaciones de radiocomunicación RF, pueden a causa de su función natural, emitir una radiación electromagnética aumentada. Deben tomarse todas las medidas necesarias para la protección de las mujeres embarazadas. También las personas con marcapasos pueden correr peligro a causa de la radiación electromagnética. El empresario/operador tiene la obligación de evaluar y señalizar las áreas de trabajo en las que exista un riesgo elevado de exposición a radiaciones.
6. Tenga en cuenta que en caso de incendio pueden desprenderse del producto sustancias tóxicas (gases, líquidos etc.) que pueden generar daños a la salud. Por eso, en caso de incendio deben usarse medidas adecuadas, como p. ej. máscaras antigás e indumentaria de protección.
7. Los productos con láser están provistos de indicaciones de advertencia normalizadas en función de la clase de láser del que se trate. Los rayos láser pueden provocar daños de tipo biológico a causa de las propiedades de su radiación y debido a su concentración extrema de potencia electromagnética. En caso de que un producto Rohde & Schwarz contenga un producto láser (p. ej. un lector de CD/DVD), no debe usarse ninguna otra configuración o función aparte de las descritas en la documentación del producto, a fin de evitar lesiones (p. ej. debidas a irradiación láser).
8. Clases de compatibilidad electromagnética (conforme a EN 55011 / CISPR 11; y en analogía con EN 55022 / CISPR 22, EN 55032 / CISPR 32)
 - Aparato de clase A:
Aparato adecuado para su uso en todos los entornos excepto en los residenciales y en aquellos conectados directamente a una red de distribución de baja tensión que suministra corriente a edificios residenciales.
Nota: Los aparatos de clase A están destinados al uso en entornos industriales. Estos aparatos pueden causar perturbaciones radioeléctricas en entornos residenciales debido a posibles perturbaciones guiadas o radiadas. En este caso, se le podrá solicitar al operador que tome las medidas adecuadas para eliminar estas perturbaciones.
 - Aparato de clase B:
Aparato adecuado para su uso en entornos residenciales, así como en aquellos conectados directamente a una red de distribución de baja tensión que suministra corriente a edificios residenciales.

Instrucciones de seguridad elementales

Reparación y mantenimiento

1. El producto solamente debe ser abierto por personal especializado con autorización para ello. Antes de manipular el producto o abrirlo, es obligatorio desconectarlo de la tensión de alimentación, para evitar toda posibilidad de choque eléctrico.
2. El ajuste, el cambio de partes, el mantenimiento y la reparación deberán ser efectuadas solamente por electricistas autorizados por Rohde & Schwarz. Si se reponen partes con importancia para los aspectos de seguridad (p. ej. el enchufe, los transformadores o los fusibles), solamente podrán ser sustituidos por partes originales. Después de cada cambio de partes relevantes para la seguridad deberá realizarse un control de seguridad (control a primera vista, control del conductor de protección, medición de resistencia de aislamiento, medición de la corriente de fuga, control de funcionamiento). Con esto queda garantizada la seguridad del producto.

Baterías y acumuladores o celdas

Si no se siguen (o se siguen de modo insuficiente) las indicaciones en cuanto a las baterías y acumuladores o celdas, pueden producirse explosiones, incendios y/o lesiones graves con posible consecuencia de muerte. El manejo de baterías y acumuladores con electrolitos alcalinos (p. ej. celdas de litio) debe seguir el estándar EN 62133.

1. No deben desmontarse, abrirse ni triturarse las celdas.
2. Las celdas o baterías no deben someterse a calor ni fuego. Debe evitarse el almacenamiento a la luz directa del sol. Las celdas y baterías deben mantenerse limpias y secas. Limpiar las conexiones sucias con un paño seco y limpio.
3. Las celdas o baterías no deben cortocircuitarse. Es peligroso almacenar las celdas o baterías en estuches o cajones en cuyo interior puedan cortocircuitarse por contacto recíproco o por contacto con otros materiales conductores. No deben extraerse las celdas o baterías de sus embalajes originales hasta el momento en que vayan a utilizarse.
4. Las celdas o baterías no deben someterse a impactos mecánicos fuertes indebidos.
5. En caso de falta de estanqueidad de una celda, el líquido vertido no debe entrar en contacto con la piel ni los ojos. Si se produce contacto, lavar con agua abundante la zona afectada y avisar a un médico.
6. En caso de cambio o recarga inadecuados, las celdas o baterías que contienen electrolitos alcalinos (p. ej. las celdas de litio) pueden explotar. Para garantizar la seguridad del producto, las celdas o baterías solo deben ser sustituidas por el tipo Rohde & Schwarz correspondiente (ver lista de recambios).
7. Las baterías y celdas deben reciclarse y no deben tirarse a la basura doméstica. Las baterías o acumuladores que contienen plomo, mercurio o cadmio deben tratarse como residuos especiales. Respete en esta relación las normas nacionales de eliminación y reciclaje.

Transporte

1. El producto puede tener un peso elevado. Por eso es necesario desplazarlo o transportarlo con precaución y, si es necesario, usando un sistema de elevación adecuado (p. ej. una carretilla elevadora), a fin de evitar lesiones en la espalda u otros daños personales.

Instrucciones de seguridad elementales

2. Las asas instaladas en los productos sirven solamente de ayuda para el transporte del producto por personas. Por eso no está permitido utilizar las asas para la sujeción en o sobre medios de transporte como p. ej. grúas, carretillas elevadoras de horquilla, carros etc. Es responsabilidad suya fijar los productos de manera segura a los medios de transporte o elevación. Para evitar daños personales o daños en el producto, siga las instrucciones de seguridad del fabricante del medio de transporte o elevación utilizado.
3. Si se utiliza el producto dentro de un vehículo, recae de manera exclusiva en el conductor la responsabilidad de conducir el vehículo de manera segura y adecuada. El fabricante no asumirá ninguna responsabilidad por accidentes o colisiones. No utilice nunca el producto dentro de un vehículo en movimiento si esto pudiera distraer al conductor. Asegure el producto dentro del vehículo debidamente para evitar, en caso de un accidente, lesiones u otra clase de daños.

Eliminación/protección del medio ambiente

1. Los dispositivos marcados contienen una batería o un acumulador que no se debe desechar con los residuos domésticos sin clasificar, sino que debe ser recogido por separado. La eliminación se debe efectuar exclusivamente a través de un punto de recogida apropiado o del servicio de atención al cliente de Rohde & Schwarz.
2. Los dispositivos eléctricos usados no se deben desechar con los residuos domésticos sin clasificar, sino que deben ser recogidos por separado.
Rohde & Schwarz GmbH & Co.KG ha elaborado un concepto de eliminación de residuos y asume plenamente los deberes de recogida y eliminación para los fabricantes dentro de la UE. Para desechar el producto de manera respetuosa con el medio ambiente, dirijase a su servicio de atención al cliente de Rohde & Schwarz.
3. Si se trabaja de manera mecánica y/o térmica cualquier producto o componente más allá del funcionamiento previsto, pueden liberarse sustancias peligrosas (polvos con contenido de metales pesados como p. ej. plomo, berilio o níquel). Por eso el producto solo debe ser desmontado por personal especializado con formación adecuada. Un desmontaje inadecuado puede ocasionar daños para la salud. Se deben tener en cuenta las directivas nacionales referentes a la eliminación de residuos.
4. En caso de que durante el trato del producto se formen sustancias peligrosas o combustibles que deban tratarse como residuos especiales (p. ej. refrigerantes o aceites de motor con intervalos de cambio definidos), deben tenerse en cuenta las indicaciones de seguridad del fabricante de dichas sustancias y las normas regionales de eliminación de residuos. Tenga en cuenta también en caso necesario las indicaciones de seguridad especiales contenidas en la documentación del producto. La eliminación incorrecta de sustancias peligrosas o combustibles puede causar daños a la salud o daños al medio ambiente.

Se puede encontrar más información sobre la protección del medio ambiente en la página web de Rohde & Schwarz.



이 기기는 가정용(B급) 전자파
적합기기로서 주로 가정에서
사용하는 것을 목적으로 하며,
모든 지역에서 사용할 수
있습니다

Quality management and environmental management

Certified Quality System
ISO 9001

Certified Environmental System
ISO 14001

Sehr geehrter Kunde,

Sie haben sich für den Kauf eines Rohde&Schwarz Produktes entschieden. Sie erhalten damit ein nach modernsten Fertigungsmethoden hergestelltes Produkt. Es wurde nach den Regeln unserer Qualitäts- und Umweltmanagementsysteme entwickelt, gefertigt und geprüft. Rohde&Schwarz ist unter anderem nach den Managementsystemen ISO9001 und ISO 14001 zertifiziert.

Der Umwelt verpflichtet

- Energie-effiziente, RoHS-konforme Produkte
- Kontinuierliche Weiterentwicklung nachhaltiger Umweltkonzepte
- ISO 14001-zertifiziertes Umweltmanagementsystem

Dear customer,

You have decided to buy a Rohde&Schwarz product. This product has been manufactured using the most advanced methods. It was developed, manufactured and tested in compliance with our quality management and environmental management systems. Rohde&Schwarz has been certified, for example, according to the ISO9001 and ISO 14001 management systems.

Environmental commitment

- Energy-efficient products
- Continuous improvement in environmental sustainability
- ISO 14001-certified environmental management system

Cher client,

Vous avez choisi d'acheter un produit Rohde&Schwarz. Vous disposez donc d'un produit fabriqué d'après les méthodes les plus avancées. Le développement, la fabrication et les tests de ce produit ont été effectués selon nos systèmes de management de qualité et de management environnemental. La société Rohde&Schwarz a été homologuée, entre autres, conformément aux systèmes de management ISO 9001 et ISO 14001.

Engagement écologique

- Produits à efficience énergétique
- Amélioration continue de la durabilité environnementale
- Système de management environnemental certifié selon ISO 14001



Customer Support

Technical support – where and when you need it

For quick, expert help with any Rohde & Schwarz equipment, contact one of our Customer Support Centers. A team of highly qualified engineers provides telephone support and will work with you to find a solution to your query on any aspect of the operation, programming or applications of Rohde & Schwarz equipment.

Up-to-date information and upgrades

To keep your instrument up-to-date and to be informed about new application notes related to your instrument, please send an e-mail to the Customer Support Center stating your instrument and your wish. We will take care that you will get the right information.

Europe, Africa, Middle East

Phone +49 89 4129 12345
customersupport@rohde-schwarz.com

North America

Phone 1-888-TEST-RSA (1-888-837-8772)
customer.support@rsa.rohde-schwarz.com

Latin America

Phone +1-410-910-7988
customersupport.la@rohde-schwarz.com

Asia/Pacific

Phone +65 65 13 04 88
customersupport.asia@rohde-schwarz.com

China

Phone +86-800-810-8228 /
+86-400-650-5896
customersupport.china@rohde-schwarz.com



Contents

1	Safety Instructions	5
2	Introduction	7
2.1	Front View	8
2.1.1	Artificial Hand.....	8
2.1.2	Ground Terminal	8
2.1.3	Schuko Socket (EUT 1)	9
2.1.4	CEE Socket (EUT 2).....	9
2.1.5	Fan.....	9
2.1.6	Limiter	9
2.1.7	Line Selection	9
2.1.8	RF Output to Test Receiver	9
2.1.9	Protective Earth Conductor Terminal	9
2.2	Rear View	10
2.2.1	Remote Control.....	10
2.2.2	Ground Terminal	10
2.2.3	CEE built-in connector	10
2.2.4	Protective Earth Conductor Terminal	11
2.2.5	Auxiliary Voltage Input	11
3	Block Diagram	12
4	Preparing for Use	13
4.1	Unpacking the Device	13
4.2	Setting Up The Device	13
4.3	Protective Earthing	14
4.4	AC Supply	15
4.5	Connecting the RF Reference Ground	16
4.5.1	Avoiding Grounding Loops	17
4.6	Connecting the Auxiliary Voltage	19
4.7	Connecting the Test Receiver	20
4.8	10 dB Attenuator	21
4.9	140 dBμV Pulse Limiter	21
4.10	Connecting the EUT	22

5	Operating the V-Network.....	23
5.1	Measurement Example.....	23
6	Remote Control.....	25
7	Maintenance and Upkeeping	27
8	Calibration and Recommended Recalibration Interval.....	28
9	Index	29

1 Safety Instructions

Before putting the device into operation for the first time, be sure to read and observe the following safety instructions as a supplement to the safety brochure supplied with the device (1171.0100.42).

DANGER

Electric shock in case of wrong connection order.

The protective earth (PE) or protective ground connection must not be removed until all other connections have been disconnected.

Put the V-network into operation in the following order (**connect additional PE first**):

1. Connect V-network to additional protective earth.
2. Connect V-network to supplying network.

Take the V-network out of operation in the following order (**disconnect additional PE last**):

1. Disconnect V-network from supplying network.
2. Disconnect V-network from additional protective earth.

All safety instructions and warnings given on the device and in this operating manual must be strictly observed.

Incorrect operation of the V-network may expose users to a life-threatening situation.

Users have to be instructed accordingly.

DANGER

Electric shock due to improper operation.

By design, V-networks exhibit high ground leakage currents. Moreover, by principle, such a device has a nonstandard isolation and no fuse in the measuring circuit (the R&S ENV432 only features a fuse in the auxiliary circuit of the ventilation system). Hence users must be protected against touching conductive parts that may carry live mains voltage.

To ensure this, the V-network must be put into operation only by qualified electrical specialists. The applicable national regulations and standards must be observed as part of the installation process.

Since the permissible limit for the leakage current in line with EN 61010-1 as well as the basic insulation for a device with degree of protection I cannot be met due to the required standard-compliant setup in line with CISPR 16-1-2 (EN 55016-1-2), additional measures must be taken to protect the user against direct or indirect contact.

The operator is responsible for ensuring that protective measures in line with VDE 0100-410 (IEC 60364-4-41) are maintained while working with the V-network. Prior to putting the V-network into operation, a secure connection must be made with the protective earth conductor available on site. This connection must fully meet the requirements for protective earth conductor connections. The connection must not be opened until the V-network has been definitively disconnected from the mains supply.

In case of flexible cable connection, it is necessary to assume that the protective earth conductor connection can come loose. Prior to putting the V-network into operation, it must be connected using an additional protective earth conductor in line with VDE 0100-540 Part 5-54 (IEC 60364-5-54) with sufficient cross-sectional area between a protective earth terminal in the test room and the protective earth conductor terminal



() on the rear panel of the R&S ENV432.

Only then may the V-network be connected to the mains supply. Removal from service must be performed in the reverse order: First disconnect the V-network from the mains supply and only then disconnect the additional protective earth conductor connection.

If "electrical separation" is used as a protective measure, an electrical specialist must decide at which points a ground connection or a connection to the protective earth terminal available on site may be made.

In general, when the R&S ENV432 is operated, make sure that the air supply is not obstructed from above or below. Since the device has air vents on the bottom side, it must be placed on a nonflammable base (e.g. metal plate) in order to prevent a fire if the ventilation system fails.

These operating instructions are part of the device and must be available to the operating personnel at all times. All safety instructions and remarks must be observed.

Neither Rohde & Schwarz GmbH Co. KG nor any of the sales organizations can assume liability for personal injury or material damages that occur in the event of incorrect usage of the device or accessory parts.

2 Introduction

The R&S ENV432 four-line V-network is used to measure disturbance voltages on mains-dependent loads.

Its main functions are as follows:

- Supply the equipment under test (EUT) with AC supply voltage or DC supply voltage
- Provide a standardized load impedance
- Deliver the unsymmetric disturbance voltage generated by the EUT to the test receiver in a defined manner
- Decouple the test circuit from mains disturbances

The R&S ENV432 V-network is built with air-core inductances (50 μH and 250 μH) and conforms to the requirements specified in CISPR 16-1-2.

Additional equipment:

- Artificial hand
- 10 dB attenuator in decoupling branch
- Pulse voltage limiter at measurement output
- Remote control interface
- Separate power supply for control electronics and remote control interface

The V-network can be operated manually or under remote control via a TTL interface.

2.1 Front View

This figure shows the front view of the R&S ENV432. The individual elements are described in more detail in the subsequent sections.



Fig. 1 Front View

- 1 = Artificial Hand
- 2 = Ground terminal
- 3 = Schuko socket single-phase (EUT 1)
- 4 = CEE socket three-phase (EUT 2)
- 5 = Push button for switching on the fans
- 6 = Push button for switching off the pulse limiter
- 7 = Rotary switch for selecting the test path
- 8 = RF output to test receiver
- 9 = Protective earth terminal

2.1.1 Artificial Hand

4 mm connector, female, with knurled clamp for connecting the artificial hand in order to mimic the influence of the user's hand while measuring the disturbance voltage.

2.1.2 Ground Terminal ()

4 mm connector, female, for connecting the reference ground during calibration.

2.1.3 Schuko Socket (EUT 1)

Connector for disturbance voltage measurements on single-phase EUTs with an alternating voltage up to 240 V and direct voltages up to 350 V. When using this connector, the maximum constant current is 16 A.

2.1.4 CEE Socket (EUT 2)

Connector for disturbance voltage measurements on three-phase EUTs with a star-type alternating voltage up to 240 V (corresponds to a delta-type alternating voltage of 415 V) and direct voltages up to 350 V. The maximum constant current per phase is 32 A.

2.1.5 Fan

Pushing the fan button activates the ventilation manually to prevent any damage due to overheating. The V-network ventilation is automatically set to full speed at an internal housing temperature of approx. 50 °C and the fan LED turns orange. If the coil temperature is > 100 °C, an acoustic alarm sounds and the fan LED turns red.

2.1.6 Limiter

Pushing the limiter button switches off the pulse limiter.

2.1.7 Line Selection

Rotary switch for selecting the test path (L1, L2, L3 and N) of the V-network to the test receiver. Depending on the test path selection the corresponding green line LED light up.

2.1.8 RF Output to Test Receiver

Output N 50 Ω, female, for connecting the test receiver.

2.1.9 Protective Earth Conductor Terminal ()

M8 threaded bolt for connecting the protective earth conductor.

2.2 Rear View

This figure shows the rear view of the R&S ENV432. The individual elements are described in more detail in the subsequent sections.



Fig. 2 Rear View

- 1 = Remote control input
- 2 = Ground terminal
- 3 = CEE built-in connector, three-phase (MAINS)
- 4 = Protective earth terminal
- 5 = Mains voltage input for auxiliary voltage and selection of mains voltage

2.2.1 Remote Control

25-contact D-Sub terminal, female, for connecting the remote control cable.

2.2.2 Ground Terminal ()

4 mm connector, female, for connecting the reference ground during calibration.

2.2.3 CEE built-in connector

CEE built-in connector for connecting the supply voltage.

2.2.4 Protective Earth Conductor Terminal ()

M8 threaded bolt for connecting the protective earth conductor.

2.2.5 Auxiliary Voltage Input

Low-temperature connector with mains filters for applying the auxiliary voltage for powering fans and control logic. The R&S ENV432 can be set for two different nominal AC supply voltages: 115 V and 230 V.

3 Block Diagram

ENV 432
Block Schematic & Cable

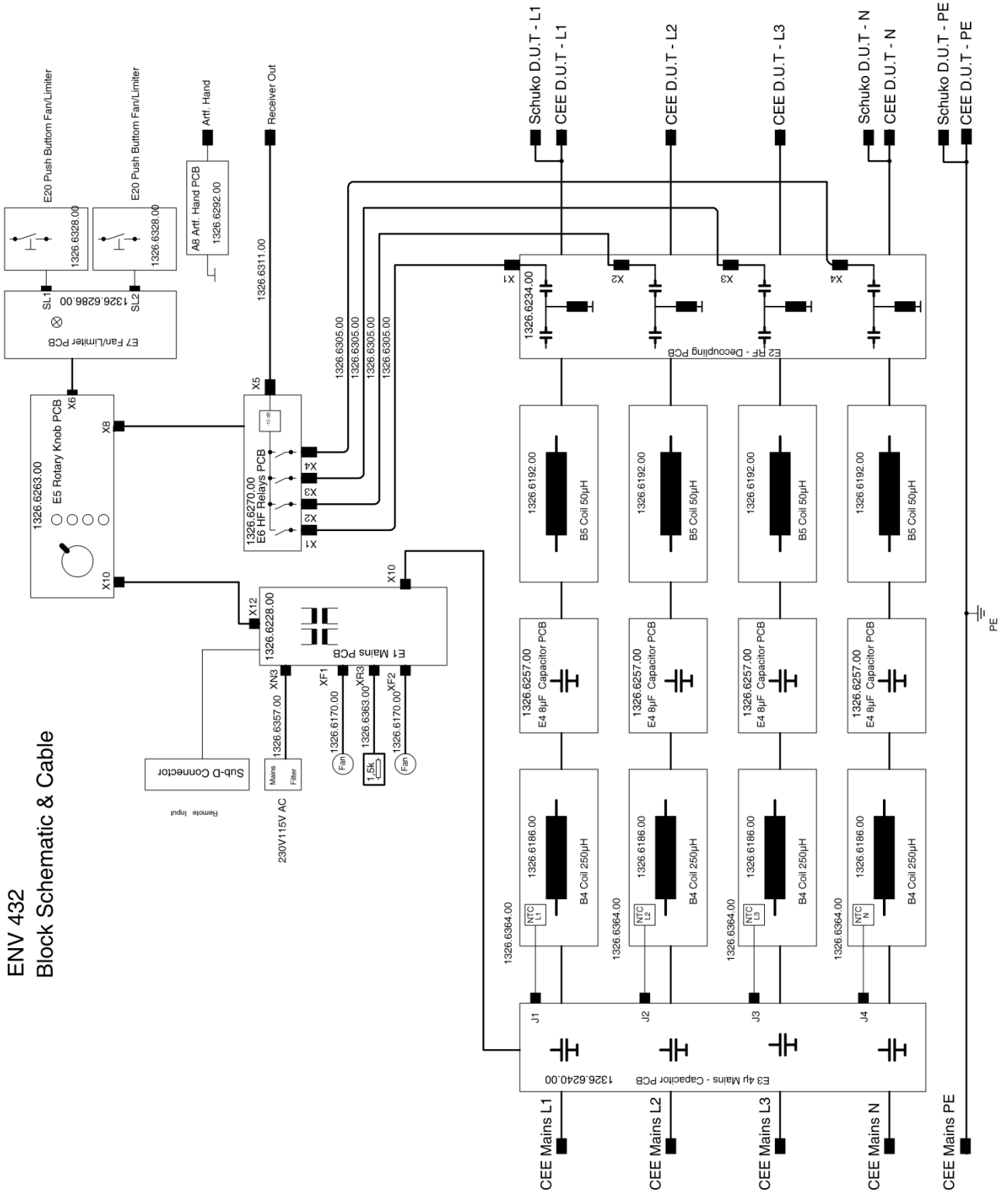

4 Preparing for Use

4.1 Unpacking the Device

Remove the device from its packaging and carefully check it for any damage. Should there be any damage, inform the carrier immediately and keep the packaging to support any subsequent claims. The original packaging is also useful for transporting or shipping the device later on.

⚠ WARNING

Both handles must be used when removing the V-network from its packaging and when carrying it. Since it is very heavy (24 kg), it is recommended to always have two persons carry the V-network. Otherwise, there is a risk of injury.

4.2 Setting Up The Device

Before putting the R&S ENV432 into operation, make sure the following requirements have been met.

- The V-network is connected to an additional protective earth conductor.
- The air vents are not blocked.
- No signal or operating voltages exceeding the permitted limits are present at the inputs.
- The maximum permissible constant current at the device's outputs is not exceeded and the outputs are not incorrectly connected.

⚠ WARNING

Be sure to observe the requirements in the safety instructions chapter as well as the section on protective earth grounding!

In general, when the R&S ENV432 is operated, make sure that the air supply is not obstructed from above or below. Since the device has air vents on the bottom side, it must be placed on a nonflammable base (e.g. metal plate) in order to prevent a fire if the ventilation system fails.

Ignoring these instructions can lead to damage to the device.

4.3 Protective Earthing

DANGER

Electric shock due to faulty protective earthing.

By design, V-networks feature a nonstandard isolation and no fuse in the measuring circuit, but may exhibit high ground leakage currents. To protect users against touching live conductive parts, provision of a protective earthing for this V-network must be ensured by qualified electrical specialists. The applicable national regulations and standards must be observed as part of the installation process.

Due to the V-network's operating principle, high leakage currents of approx. 1200 mA are applied to the housing. The housing of the V-network is applied to the AC supply voltage at relatively low impedance. For this reason, the V-network must always be connected to the protective earth prior to putting it into operation.

In case of flexible cable connection, it is necessary to assume that the protective earth conductor connection can come loose. Prior to putting the V-network into operation, it must be connected using an additional protective earth conductor in line with VDE 0100-540 Part 5-54 (IEC 60364-5-54) with cross-sectional area of 6 mm² between a protective earth terminal in the test room and the protective earth conductor terminal

() on the rear panel of the R&S ENV432. In this manner, the housing voltage will remain under 4 V even in case of a faulty EUT, i.e. in the event of a short circuit.

Only then may the V-network be connected to the mains supply. Removal from service must be performed in the reverse order: First disconnect the V-network from the mains supply and only then disconnect the additional protective earth conductor connection.

Make sure that the RF reference ground is not impacted by disturbance voltages (e.g. from an industrial network) when the protective earth terminal is connected to the protective earth. If this is the case, the protective earth must be connected via a protective earth choke. With the choke, make sure that no voltages constituting a shock hazard are applied to the housing.

If "electrical separation" is used as a protective measure, an electrical specialist must decide at which points a ground connection or a connection to the protective ground terminal available on site may be made.

WARNING

The protective earth connection must not be removed until all connections have been disconnected from the mains supply. All safety instructions and warnings given on the device and in this user manual must be strictly observed.

4.4 AC Supply

DANGER

Electric shock due to faulty AC supply installation.

By design, V-networks feature a nonstandard isolation, no fuse in the measuring circuit, and exhibit high ground leakage currents. To protect users against touching live conductive parts, provision of the AC supply for this V-network must be ensured by qualified electrical specialists. The applicable national regulations and standards must be observed as part of the installation process.

Connect the supply voltage (Power) to the CEE built-in (MAINS) connector at the rear side. An appropriate CEE connector for establishing connecting lines is part of the equipment supplied.

In line with the insulation requirements stipulated in the standard CISPR 16-1-2 (EN 55016-1-2), each phase of the V-network is connected to housing ground via 8 μ F. This is why the V-network may not be operated with a residual current circuit breaker connected ahead of it. Additional measures must be taken to protect the user against direct or indirect contact.

V-networks such as the R&S ENV432 may also not contain any power fuses. Therefore, the connected mains supply must be sufficiently fused. If the EUT is operated on the single-phase SCHUKO socket outlet (EUT 1), the maximum permissible constant current is 16 A and the AC supply must thus be fused for 16 A. If the EUT is operated on the three-phase CEE socket (EUT 2), the maximum permissible constant current is 32 A and the AC supply must thus be fused for 32 A.

The device does not have an on/off switch. An interrupting device that the user can easily reach must be provided at the AC supply end to prevent the user from working with AC supply voltage. The AC supply voltage must not be activated until the V-network and the equipment under test are completely connected. Removal from service must be performed in the reverse order: First disconnect the V-network from the mains supply and only then disconnect the EUT from the V-network.

WARNING

The V-network is not fused in the operating circuit. The user must ensure that the operating circuit between the power supply and the V-network's power connector is fused correctly.

4.5 Connecting the RF Reference Ground

The V-network is connected via the power connector to the protective earth conductor (PE) of the mains supply; however, this is not suitable as an RF reference ground for measuring disturbance voltages. Therefore, the V-network must be connected to an appropriate RF reference ground to obtain reproducible and correct measurement results.

The RF reference ground that is used can be connected flush to the laterally arranged ground bar (2) using a wide metal foil and seven M6 screws (1) (see Fig. 3).

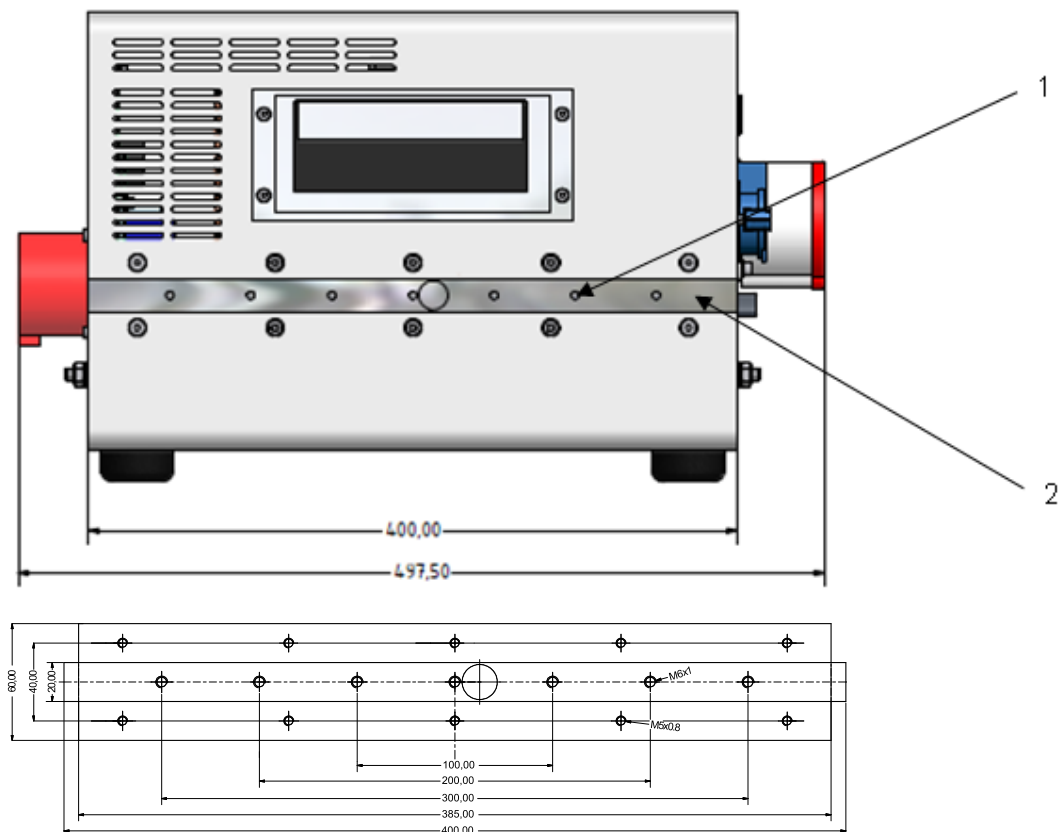

Fig. 3 Connection to RF reference ground

Make sure that the RF reference ground is not impacted by disturbance voltages (e.g. from an industrial network) when the protective earth conductor is connected to the protective earth. If this is the case, the protective earth must be connected via a protective earth choke. With the choke, make sure that no voltages constituting a shock hazard are applied to the housing.

4.5.1 Avoiding Grounding Loops

To avoid grounding loops, the V-network should be grounded only once in the test setup, if possible. An example of using a protective earth choke (PE choke) was already given above (ensuring that the RF reference ground is not impacted by disturbance voltages from an industrial network). Fig. 4 shows an arrangement with several V-networks ("V-NNB"), source: CISPR 16-2-1:2008-10 (Edition 2).

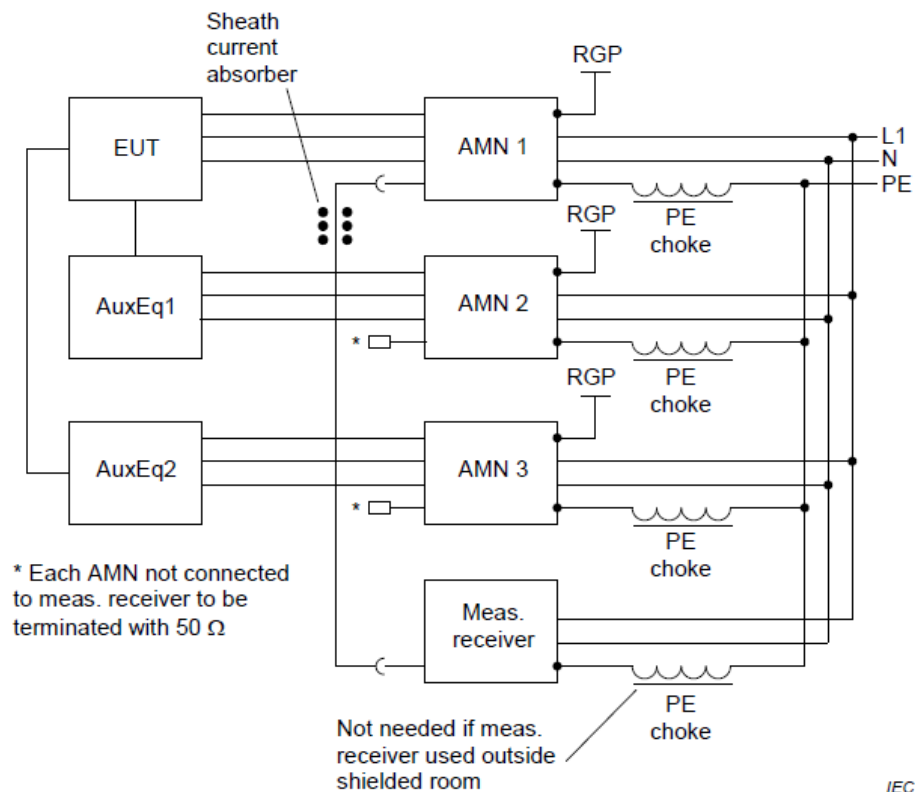

Fig. 4 Arrangement of PE chokes to avoid grounding loops

PE chokes for currents up to about 30 A are common. In case of higher currents, you can make them yourself by using ferrite toroidal cores. The following rule applies: In case of a short circuit, the voltage drop at the PE choke must not exceed 4 V.

A sheath current absorber for the coaxial cable can be implemented as shown in Fig. 5. The figure illustrates the attenuation of an absorber with the following material:

Core material: N30; AI = 5400 nH

Dimensions: Toroidal core 58 mm x 40 mm x 17 mm

EPCOS order no: B64290-A40-X830

Number of turns: 20 (RF cable)

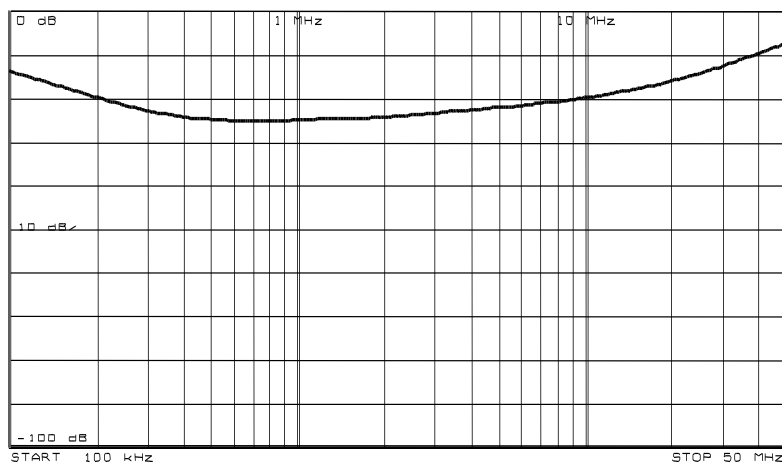

Fig. 5 Attenuation of sheath current choke measured in 150 Ω test setup

An attenuation of 20 dB means that the effective impedance of the sheath current choke is approx. 1500 Ω .

4.6 Connecting the Auxiliary Voltage

DANGER

Risk of fire in case of auxiliary voltage breakdown.

The R&S ENV432 must not be operated without the auxiliary voltage since this voltage is necessary for operation of the ventilation system. Failure of the ventilation system can lead to overheating of the V-network and even cause a fire in the worst case, while also burns upon contact with the V-network are possible.

Prior to connecting the auxiliary voltage, it is necessary to check whether the AC supply voltage that is set on the V-network corresponds to the local AC supply voltage. The R&S ENV432 can be set for two different nominal AC supply voltages: 115 V and 230 V. In the 115 V setting, the nominal AC supply voltage range is 100 V to 120 V. In the 230 V setting, the nominal AC supply voltage range is 220 V to 240 V.

WARNING

Make sure to read and understand the safety instructions in this manual before setting the device for a different AC supply voltage or replacing a fuse. The F1/F2 line fuses are dimensioned to provide protection against overcurrent situations and short-circuits in both voltage ranges. If the fuse is exchanged, the type IEC 60127-2/5 T2A H 250V must be used (two spare fuses are part of the equipment supplied).

The AC supply voltage is changed as follows:

1. Remove the fuse holder in the low-temperature connector on the device's rear panel
(it can be removed only when the power cable is not connected)
2. Remove the line voltage selector using a suitable lifting tool such as a screwdriver, size 1
3. Set the AC supply voltage by correctly inserting (rotating) the line voltage selector
4. Close the flap on the power connector

The desired AC supply voltage should be visible in the display window.

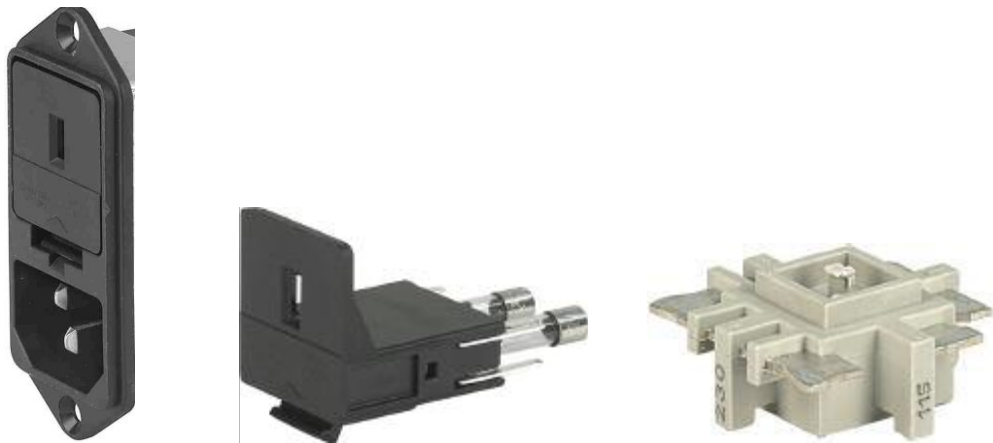

Fig. 6 Low-temperature socket, fuse holder and line voltage selector

After selection of the voltage range, connect the V-network to the supply voltage using the supplied power cable. If the V-network is correctly connected, one of the four green LEDs for displaying the test path should light up (depending on the position of the LINE SELECTION rotary switch).

ACHTUNG

If the V-network is connected to 230 V and the voltage selector is set to 115 V, the V-network's internal F3/F4 fuses may blow. The internal F3/F4 fuses may be replaced only by an authorized Rohde & Schwarz service center (two spare fuses are part of the equipment supplied).

4.7 Connecting the Test Receiver

Connect the test receiver using a 50 Ω coaxial cable to the test receiver output (50 Ω N female connector TO TEST RECEIVER).



The external conductor of the N female connector is connected to the grounding bars of the V-network via the front panel.

4.8 10 dB Attenuator

The built-in 10 dB attenuator attenuates the disturbance voltage emitted by the EUT by 10 dB.

The attenuator ensures the 50 Ω termination required to meet the impedance tolerance, improves matching with the test receiver and provides a sufficiently high ohmic internal resistance to ensure correct functioning of the pulse limiter.



See voltage division factor in the test report.

4.9 140 dB μ V Pulse Limiter

The switchable pulse limiter limits voltage peaks up to 140 dB μ V at the RF output. This corresponds to a measured disturbance signal level of 150 dB μ V. Please note that the test receiver only covers a 9 kHz spectral component of a broadband disturbance signal.



When the device is powered on, the pulse limiter is always activated and must be intentionally switched off. This ensures that it cannot be accidentally switched off.

If the pulse limiter is switched on, the green LED lights up.

The voltage peaks are caused, for example, by

- High disturbance voltages originating from broadband interferers
- Switching on and off
- Pulses from the mains supply

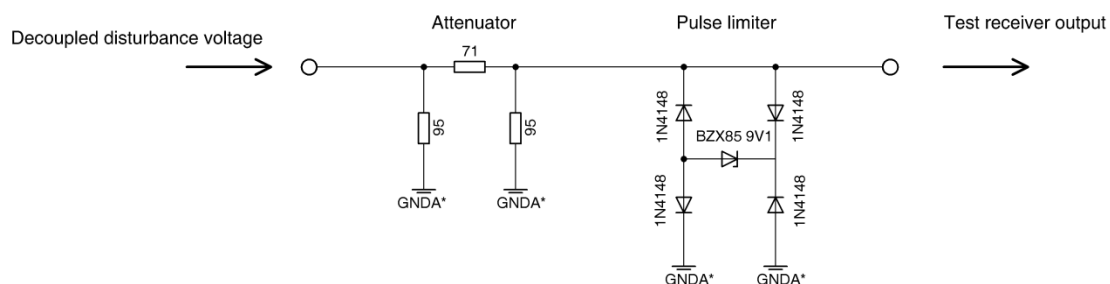

Fig. 7 Basic principle of pulse limiter

4.10 Connecting the EUT

Connect the equipment under test (EUT) with the connecting lines to the front-panel single-phase SCHUKO socket outlet (EUT 1) or the three-phase CEE outlet (EUT 2) on the R&S ENV432. The maximum permissible constant current is equal to 16 A for the SCHUKO socket outlet and 32 A for the CEE outlet.



The user must ensure that the cross-sectional area of the double-insulated connecting cables is sufficient for the powerconsumption of the EUT. For operation on the CEE outlet with a maximum permissible constant current of 32 A, a line cross-section of at least 4 mm² is required. The cable's outer diameter should be at least 22 mm to ensure adequate strain relief.

An appropriate CEE connector for establishing connecting lines is part of the equipment supplied.

In order to mimic the influence of the user's hand while measuring the disturbance voltage, usage of an "artificial hand" is required for EUTs that are normally held in the hand. The artificial hand consists of a metal foil that must be connected to the RF reference ground via an RC combination. The RC combination is a series connection of a 220 pF capacitor C and a 510 Ω resistor R that is built into the R&S ENV432. It can be connected to the EUT via the 4 mm banana jack on the front (ARTIFICIAL HAND).

5 Operating the V-Network

The V-network is not fused in the three-phase circuit. The user must ensure that the operating circuit between the power supply and the power connector of the V-network is fused correctly (see also chapter AC Supply).

When the R&S ENV432 is operated, make sure that the air supply from above and below and from the side is not obstructed. The device may not be operated unsupervised and must be placed on a nonflammable base (e.g. metal plate) in order to prevent a fire if the ventilation system fails.

Whenever the V-network is put into operation, check the correct functioning of the fans by pressing the fan button. This is required to prevent any damage due to overheating.



The V-network ventilation is automatically set to full speed at an internal housing temperature of approx. 50 °C and the fan LED turns orange if the auxiliary voltage is connected to the AC supply. If the coil temperature is > 100 °C, an acoustic alarm sounds and the fan LED turns red.

In case of a high constant current load, the temperature of the connection elements and the connection lines must be checked from time to time.

WARNING

If the audible fanalarm sounds and the fanLED turns red, immediately disconnect the V-network from the test load. The surface of the device can seriously overheat, causing a risk of burns. If this happens, the device must undergo servicing and be repaired if necessary.

5.1 Measurement Example

Fig. 8 shows the test setup for measuring disturbance voltages on a hand drill. The artificial hand must be connected for this type of EUT. Three metal foils are arranged on the hand drill and connected to the artificial hand (ARTIFICIAL HAND).

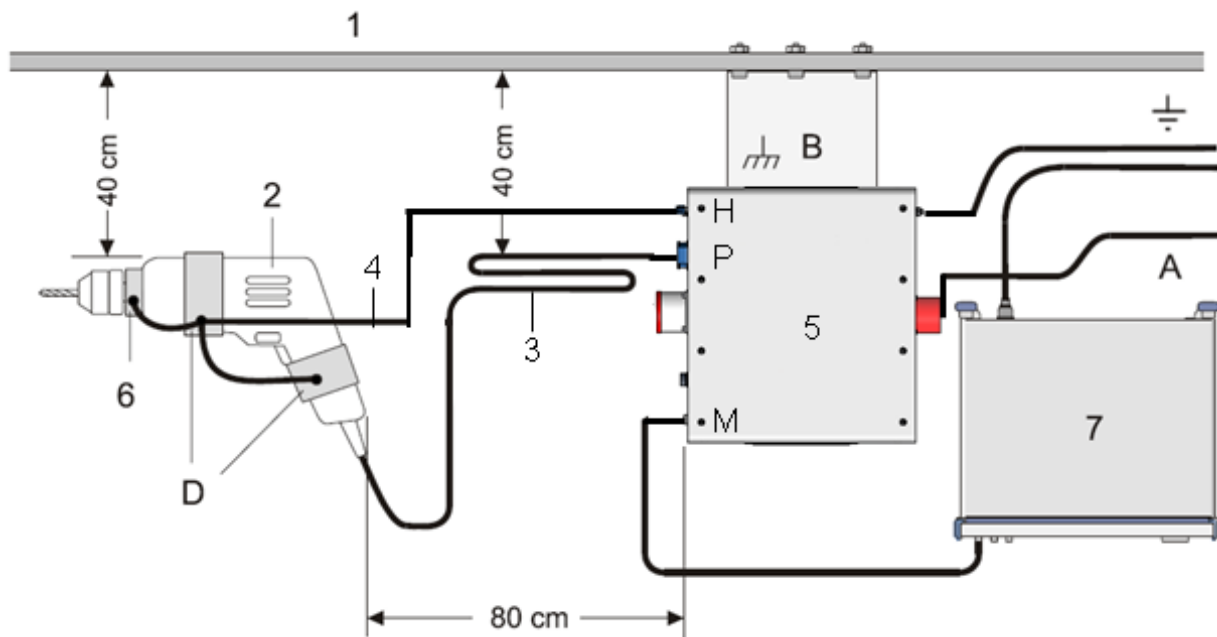

Fig. 8 Measurement example (hand drill)

Position	Function
1	Vertical RF reference ground, metal panel at least 2 m x 2 m
2	EUT
3	AC supply cable
4	Separate connecting line to artificial hand (ARTIFICIAL HAND)
5	V-network
6	Exposed metal collar
7	Test receiver
A	Connection to power supply
B	Connection to RF reference ground, low induction (e.g. brass plate 0.2 mm thick)
P	Connection to EUT (EUT 1)
H	Connection to artificial hand (ARTIFICIAL HAND)
M	Connection to test receiver (TO TEST RECEIVER)
D	Metal foils

6 Remote Control

The test path of the V-network to the test receiver can be selected manually using the rotary switch or via remote control.

For remote control, the V-network is connected to the test receiver via a connecting cable.

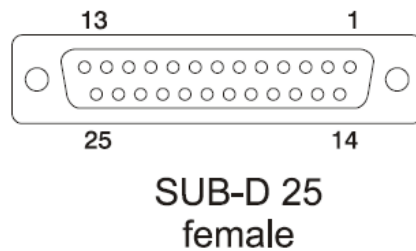

Fig. 9 Pin assignment for rear remote control connector (REMOTE CONTROL)

The test paths L1, L2, L3 and N are switched as shown in [Table 1](#):

Table 1

Pin 14	Pin 15	Pin 16	Pin 17	Selected line
L	H	H	H	N
H	L	H	H	L1
H	H	L	H	L2
H	H	H	L	L3

L level = 0 V to 0.4 V
H level = 2 V to 5 V

Remote control is activated by applying the L level to pin 12:
(remote control ON = L at pin 12)

For remote control with the R&S EMI test receivers (ESL, ESRP, ESR and ESU) as well as in the EMC32 software, the independent operating menu for the ENV432 applies. For control with the ESU, the EZ-21 connecting cables (3 m or 10 m) are used. For the ESL, ESRP and ESR, the EZ-29 connecting cables (3 m or 10 m) are used.

For remote control with R&S EMI test receivers (ESHS10, ESHS20/30, ESAI/ESBI/ESMI, ESCS, ESS, ESPI and ESCI) as well as in the ES-K1 and ESXS-K1 EMI software, the operating menu for the ESH2-Z5 V-network also applies for control of the ENV432.

For control of the R&S ENV432 with the R&S ESxl EMI test receivers (ESAI; ESBI; ESMI), the EZ-22 connecting cable is used. For control with other test receivers, the EZ-21 connecting cables (3 m or 10 m) are used.



The pulse limiter cannot be remote-controlled. For reasons of safety, the pulse limiter is switched on during remote control. If impairment of the disturbance spectrum is suspected due to pulse limiting, the pulse limiter can be switched off on the front panel and the measurement repeated manually.

7 Maintenance and Upkeeping

The device does not need any periodic maintenance. Maintenance is essentially restricted to cleaning the exterior of the device. Remove dirt from the housing with a damp cloth. Do not use aggressive cleaning agents. The device should be switched off during cleaning.

The AC supply contacts (SCHUKO; CEE; low-temperature connector) are subject to wear and tear due to mechanical and electrical influences. Accordingly, the AC supply contacts should be regularly checked for bent, corroded or broken pins or sockets as well as any signs that a fire might have occurred. Damaged AC supply contacts must be replaced!

8 Calibration and Recommended Recalibration Interval

The R&S ENV432 V-network was calibrated by the manufacturer after completion of production and was sent to the Rohde & Schwarz warehouse together with a calibration certificate. Since the V-network is neither electrically nor mechanically strained in the period between calibration and delivery to the warehouse and since aging of V-networks in the warehouse is negligible due to the lack of active components, the interval up to the first recalibration is counted from the date of delivery.

Recalibration may be performed only by the manufacturer or an authorized Rohde & Schwarz calibration center.

The recommended recalibration interval is 1 year.

9 Index

Attenuator	21	Grounding loops	17
Auxiliary Voltage	19	Maintenance and upkeeping	27
Block diagram	12	Measurement example	23
Calibration	28	Protective earthing.....	14
Calibration interval	28	Pulse limiter.....	21
Connecting the Auxiliary Voltage	19	Rear View	10
Connection		Remote control	25
Equipment under test (EUT)	22	RF reference ground.....	16
RF reference ground.....	16	Safety Instructions	5
Test receiver.....	20	Setting up the device	13
Equipment under test (EUT)	22	Unpacking the device.....	13
Front View	8		